

# TA-BVS 240/243, 140/143

Installation, operation and maintenance manual

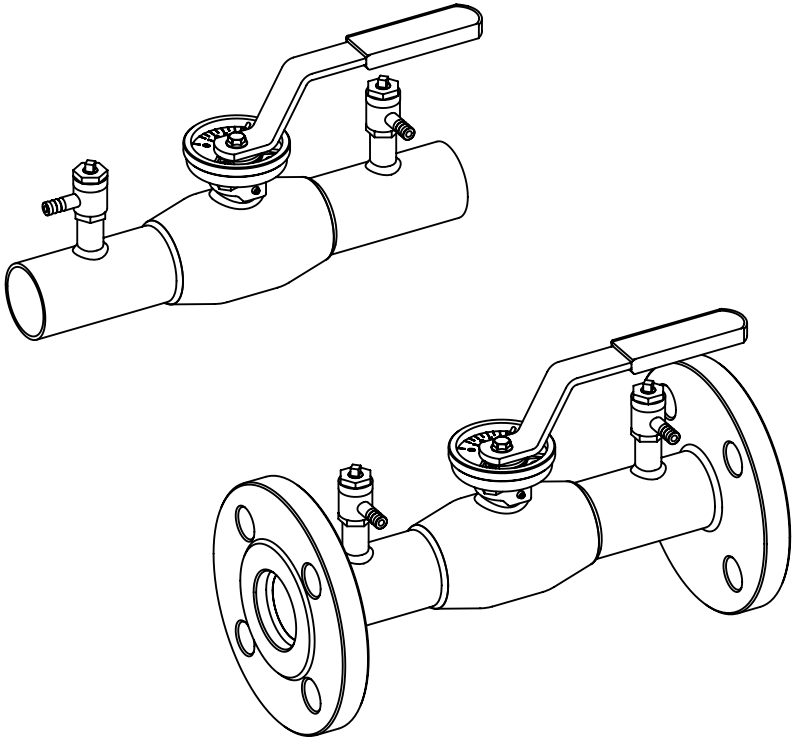

# Contents

1. General	4
2. Valve identification	5
3. Unloading and storage	6
4. Valve installation	7
4.1 Installation of valve with weld connections	9
4.2 Installation of valve with flanges	10
4.3 Installation at the end of pipeline	11
4.4 Before commissioning	11
4.5 Commissioning and Pressure testing	12
4.6 Defining the pre-set value	13
4.7 Setting the pre-set value	13
4.8 Measuring the flow rate through the valve	13
5. Maintenance	14



**NOTE:**

This manual must be read and its instructions must be followed when installing, operating and/or performing maintenance on the valve as well as its manual gear.

---

These instructions are of general nature and do not cover all possible operating scenarios. For more specific guidance on the installation, operation and maintenance of the valve or its suitability for an intended use, please contact IMI Hydronic Engineering.

IMI Hydronic Engineering reserves the right to make alterations to these instructions.

IMI Hydronic Engineering is not responsible for damages caused by incorrect transportation, handling, installation, operation or maintenance. Furthermore, IMI Hydronic Engineering is not responsible for damage caused by foreign objects or impurities.

# Warnings and symbols

Ignoring the warnings and symbols may lead to serious injury or equipment damage. Persons authorized to use the equipment must be familiar with the warnings and instructions.

Appropriate transportation, storage and installation as well as careful commissioning are essential to ensure faultless and stable operation.

The following symbols are used in this manual to draw attention to actions essential to ensure the proper use and safety of the device.



**Meaning of the symbol: NOTE**

The NOTE symbol is used for actions and functions that are essential for the proper use of the device. Ignoring this symbol may have harmful consequences.



**Meaning of the symbol: WARNING**

The WARNING symbol is used for actions and functions that, if carried out incorrectly, may lead to injury or equipment damage.

---

# 1. General

TA-BVS balancing valves are suitable for shut-off and balancing purposes in heating and cooling systems (HVAC).

Steel balancing valve TA-BVS 140/143 (color blue) is designed for clean mediums such as oxygen-free water or glycol.

Stainless steel balancing valve TA-BVS 240/243 (color grey) is designed for clean mediums. These stainless steel balancing valve is suitable also many industry systems where medium is for instance process water, ethanol, methanol, glycol or freezium.

These balancing valves can be used within the following pressure-temperature range. Please note that the maximum allowable working pressure depends on the operating temperature.

## Chart 1

Pressure-temperature chart.

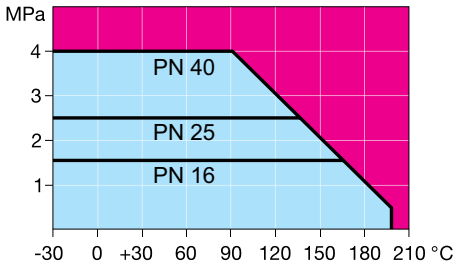

### NOTE:

When intending to use the valve for other media or applications please contact IMI Hydronic Engineering to ensure its suitability.

For detailed technical information including dimensions and weights, torques, Kv-values etc., please refer to IMI Hydronic Engineering's technical leaflet available on [www.imi-hydronic.com](http://www.imi-hydronic.com).

## 2. Valve identification

The identification plate locates at the valve body. It has the following information:

**Figure 1.** Identification plate.

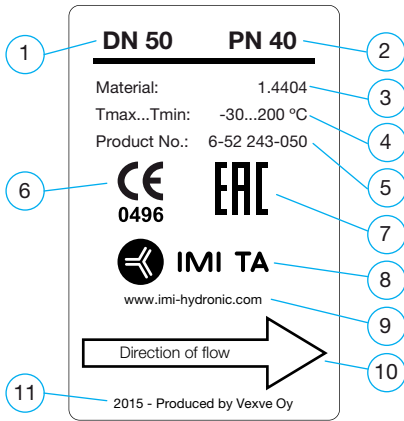

1. Valve size
2. Pressure class
3. Valve body material
4. Allowed temperature range
5. Article number
6. CE mark and notified body number
7. Eurasian Customs Union
8. Supplier
9. Supplier website
10. Direction of flow
11. Manufacturing year and manufacturer

### 3. Unloading and storage

Check that the contents of the delivery is as ordered. Check that the valve and related equipment have not been damaged during transportation.

Store the valve carefully before installation, preferably in a well-ventilated, dry place, on a shelf or a wooden grid to protect it from rising damp.

Protect bare metal surfaces, shaft parts, and flange surfaces with anti-corrosive agent before storage.

The valve must be transported to the installation site in a sturdy package. Do not remove the flow port protectors before installation. Protect the valve from sand, dust, and other impurities.

Use lifting ropes when lifting the large size valves. It is forbidden to lift the valve by its actuator or stem (see Fig. 2).



**NOTE:**

Take the weight of the valve into account when handling it.

When delivered, the valve is in the open position. During storage, the valve must also be in the open position.

The maximum storage time is two years.

#### Packaging

The products are protected during transportation with special packaging. The packaging consists of environmentally friendly materials that are easy to sort and recycle. Recycling the packaging materials at designated waste collection points is recommended.

The following packaging materials are used: wood, cardboard, paper, and polyethylene sheets.

#### Recycling and disposal

Nearly all parts of the valve are made of recyclable materials. The material type is marked on most parts. Separate recycling and disposal instructions are available from the manufacturer. The valve can also be returned to the manufacturer for recycling and disposal against a fee.

**Figure 2.** Lifting the valve.

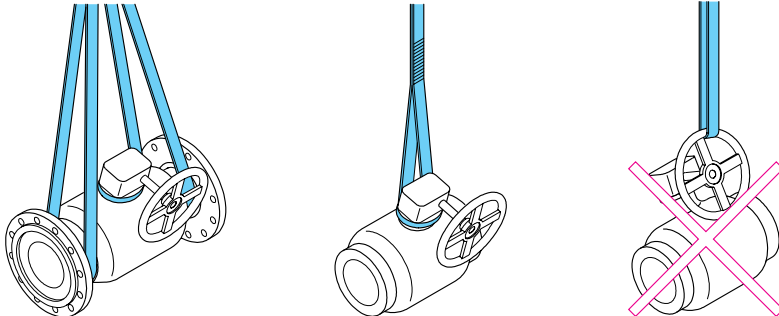

## 4. Valve installation

---



**WARNING:**

Incorrect installation may result in serious personal injury and it may damage or cause malfunction of the equipment. These instructions must therefore be followed carefully when installing the valve. These general instructions do not cover all possible operating scenarios. For more specific guidance on the use of the valve or its suitability for an intended use, please contact IMI Hydronic Engineering.

---

- Do not remove the flow port protectors before installation. Keep the valve protected from sand, dust, and other impurities.
  - If the valve was delivered with the actuator installed, avoid removing the actuator during installation.
  - Incorrect re-installation or adjustment of the actuator will result in a high risk of damage and leakage.
  - Exercise extreme caution when testing the valve before installation in the pipeline.
  - The valve or valve assembly must not be lifted from the actuator. Dropping or incorrect lifting of the valve can result in personal injury or equipment damage.
  - Use one of the allowed lifting methods shown in Figure 2.
- 



**NOTE:**

The valve must be used only in applications for which it is intended.

---

### Prior to installation

- Remove the flow port protectors and check that the inside of the valve is clean.
- 



**WARNING:**

The pipeline and valve shall be carefully cleaned prior to installation as any welding debris or other impurities can damage the valve.

---

**Following minimum installation distances should be followed:**

In the picture  $D$  = pipeline diameter

**Figure 3.** Minimum installation distances

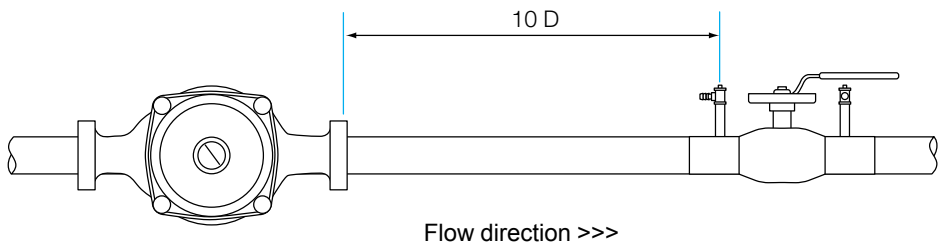
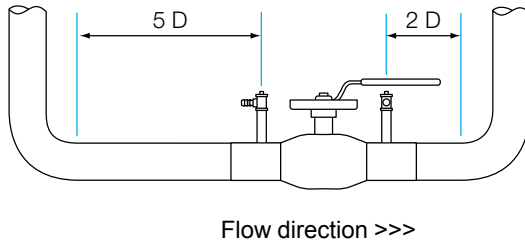



## 4.1 Installation of valve with weld connections

It is recommended to use the electric welding (TIG, MIG).  
Valve size DN 125 and bigger must be welded to the pipeline by using electric welding.

### Welding

Do not overheat the valve. Use cooling during the welding. Use wet fabric to protect the valve seat from excess heat during the welding. The welder should have the proper qualification to do this kind of welding procedures.

The valve must first be bridged to the pipeline using spot welding, with 4–8 seams alternately on opposite sides of the valve.

### When valve is installed in a horizontal position

When welding the valve, it must be in the open position in order to protect the surface of the ball from welding contamination (See Fig. 4.3).

### When valve is installed in a vertical position

When making the upper seam welding, the valve must be open in order to protect the surface of the ball from welding contamination (see Fig. 4.1).

When making the lower welding seam the valve must be closed to avoid the overheating of the valve (see Fig. 4.2).

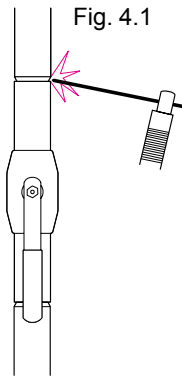

Fig. 4.1

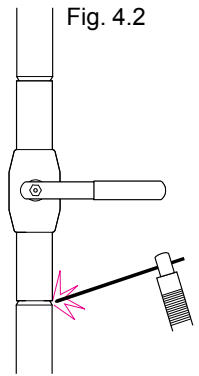

Fig. 4.2

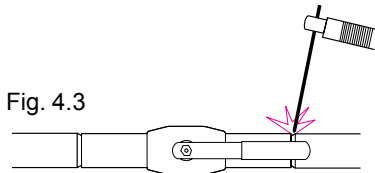

Fig. 4.3

**Figure 4.1.** Vertical position  
When welding the upper seam the valve must be in open position.

**Figure 4.2.** Vertical position  
When welding the lower seam the valve must be in closed position.

**Figure 4.3.** Horizontal position  
The valve must be in open position.

Cool down the valve (after welding) before normal operation. The valve may not be opened or/and closed after the welding before it has cooled down.

## 4.2 Installation of valve with flanges

- Valve may be installed only by an authorized mechanic, following valid norms and standards.
- The valve must remain open during installation to ensure that any residue or dirt does not damage the sealing faces
- The sealing faces of the pipe flanges must be parallel to the valve sealing faces and correctly aligned.
- The length of the valve must be the same as the distance between the flanges in the pipe line, taking into consideration the gasket.
- The flanges in the pipeline must be compatible with valve flanges. For detailed information please refer to the standard EN1092-1.
- The bolts and nuts used on installation must be selected to match operating conditions at installation location. Bolts and nuts must also fulfill requirements of the pressure, temperature, flange material and gasket. For detailed information please refer to the standards EN1515-1, EN1515-2 and EN1515-4.
- The gasket used on installation must be selected to match operating conditions, temperature, pressure and medium. Gasket dimensions must be compatible with sealing faces of the flanges. For detailed information please refer to the standard EN1514.
- Recommended installation position for the valve is with the shaft in the vertical or horizontal position.

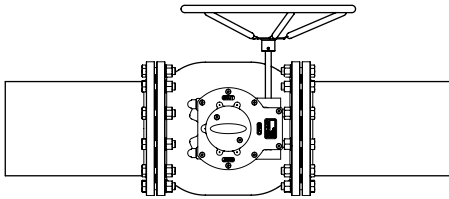

**Figure 7.** Horizontal installation.

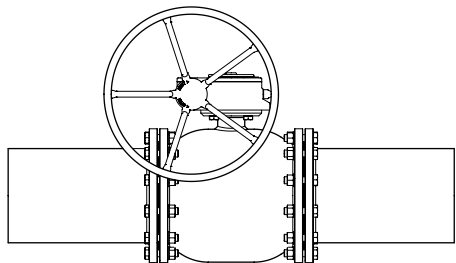

**Figure 8.** Vertical installation

### 4.3 Installation at the end of pipeline

---



**NOTE:**

Do not use the valve at the end of the pipeline – a blank flange must always be installed after the valve (see Figure 9. and 10.).

---

When the valve is installed at the end of the pipeline, there is a risk of corrosion-causing oxygen-rich water or air collecting on the empty rear side of the valve. To prevent corrosion, the space after the valve must be filled with oxygen-free water.

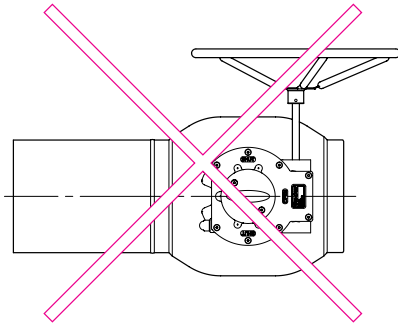

**Figure 9.** Do not use the valve at the end of the pipeline.

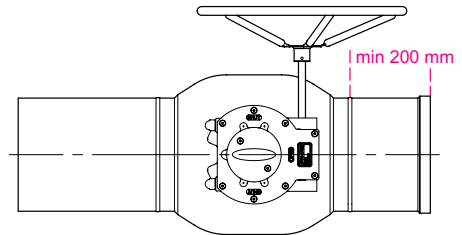

**Figure 10.** Blank flange.  
Min. 200 mm pipe must be installed between the valve and the blank flange.

---



**NOTE:**

If the valve is located near to the blind flange at the end of the pipeline, valve must be in the fully open position to prevent a closed space from forming between the valve and blind flange. If water in the closed space expands (for example due to temperature), it may damage the valve.

---

### 4.4 Before commissioning

To avoid pressure shocks and to reduce the forces caused by opening the valve under pressure, it is recommended to use a by-pass valve in connection with valves of size DN 150 and larger (see Fig. 11).

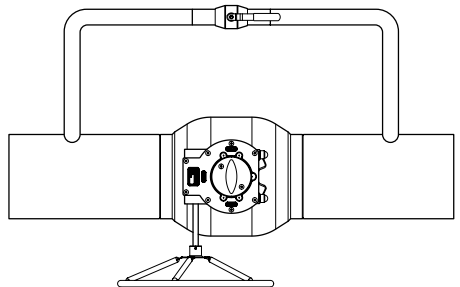

**Figure 11.** By-pass valve.

## 4.5 Commissioning and Pressure testing

Exceeding of permitted values marked on the valve may damage the valve and, in the worst case, cause uncontrolled venting of the pressure. This leads to equipment damage and possibly also to personal injuries. The largest allowable testing pressure is 1,1xPN, when the valve is closed. During the pipeline pressure testing (1,5xPN), the valve must be open.

## 4.6 Defining the pre-set value

Pre-set value of a valve can be defined by desired Kv-value of the valve.

- If the desired Kv-value is known, the suitable valve size and pre-set value can be checked from the table 1.
- If the desired Kv-value is not known, suitable valve size and pre-set value can be determined with the help of Kv-curves, see technical specification on [www.imi-hydronic.com](http://www.imi-hydronic.com) in case the desired flow rate and pressure drop across the valve are known.

**Table 1.** Kv-values

Set value	DN												
	15/20	25	32	40	50	65	80	100	125	150	200	250	300*
1,0	-	-	0,39	0,60	1,26	2,52	3,42	6,48	6,84	13,7	19,7	35,0	54,5
1,5	-	0,35	0,57	1,01	1,80	3,64	5,37	9,47	13,3	20,2	20,2	51,2	80,0
2,0	0,14	0,49	0,83	1,48	2,70	4,75	7,31	12,5	18,0	26,6	38,4	66,5	105
2,5	0,28	0,99	1,08	2,02	3,55	6,34	10,2	16,3	24,3	35,5	51,1	90,0	142
3,0	0,42	1,36	1,44	2,70	4,39	7,92	13,1	20,1	30,6	44,3	63,8	110	176
3,5	0,61	1,66	1,80	3,24	5,61	9,78	16,1	24,5	37,8	55,1	79,3	140	220
4,0	0,80	2,00	2,30	3,96	6,84	11,6	19,1	28,8	45,0	65,9	95,0	165	260
4,5	1,02	2,40	2,74	4,86	8,34	14,2	23,3	35,8	55,3	84,1	121	215	336
5,0	1,24	3,00	3,42	5,98	9,83	16,7	27,5	42,8	65,5	102	147	260	408
5,5	1,64	3,50	4,21	7,18	11,9	20,9	33,2	51,8	81,7	127	183	325	510
6,0	2,04	4,50	5,11	8,57	14,0	25,2	38,9	60,8	97,9	152	219	380	600
6,5	2,64	5,10	5,97	10,2	16,9	29,5	46,3	75,4	122	197	282	500	785
7,0	3,24	6,70	7,27	12,3	19,8	33,8	53,6	90,0	146	241	325	576	950
7,5	3,84	7,30	8,64	14,4	23,4	39,8	64,6	113	177	290	417	740	1156
8,0	4,45	9,30	10,1	17,6	27,0	45,7	75,6	137	209	338	486	866	1353
8,5	5,04	10,0	11,5	20,9	30,6	53,5	91,8	169	251	400	576	1020	1594
9,0	5,83	12,6	13,1	22,6	34,2	61,2	108	216	294	461	660	1170	1840

\*) TA-BVS 140/143 only

## 4.7 Setting the pre-set value

### Valves $\leq$ DN 150 (Fig. 12.1)

- Set the desired pre-set value (1)
- Open the locking screw of the limiter (2)
- Move the limiter against the edge of the scale plate (3)
- Tighten the locking screw of the limiter (2)

### Valves $\geq$ DN 200 (Fig. 12.2)

- Set the desired pre-set value (1)

**Figure 12.**  
Setting the pre-set value.

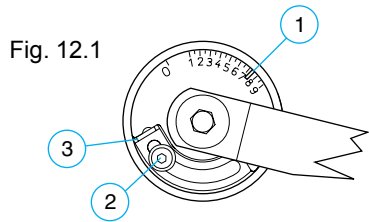
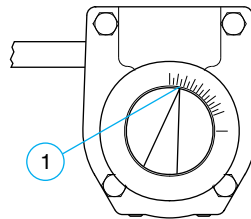

Fig. 12.2



## 4.8 Measuring the flow rate through the valve

Flow rate through the valve can be measured by using special flow measuring devices. These devices measure the pressure drop across the valve and calculate the flow rate based on the pressure drop measurements.

For more detailed information on measuring the flow rate, please refer to user manuals of flow meters. For more information on suitable flow meters, please contact IMI Hydronic Engineering.

## 5. Maintenance

TA-BVS balancing valves are virtually maintenance free.  
Correct choice of valve as well as careful installation, commissioning, and use significantly reduce any need for maintenance.



**WARNING:**

When the valve is installed in the line, its surface temperature may be dangerously high.  
Protect yourself against burns.

---

**We recommend checking the following periodically:**

- Check that the valve is free from surface damage and shaft leaks, and carefully repair any damage.
- To ensure long-term operational reliability, even when seldom used (around ten times a year or less), we recommend the following:
- Approximately six months after commissioning and then once a year, inspect the valve for shaft leaks, check the manual gear / actuator, and ensure the tightness of the screws between valves.

In case of need to replace O-ring seal then please contact IMI Hydronic Engineering.



*We reserve the right to introduce technical alterations without previous notice.*



**Hydronic** Engineering

[www.imi-hydronic.com](http://www.imi-hydronic.com)